

WARNING DEATH MAY OCCUR IF TANK IS ENTERED WITHOUT PROPER EQUIPMENT

NOTE: SEE INNER WALL PHOTO ON THE "EXCLUSIVELY AT SKAW'S" PAGE.

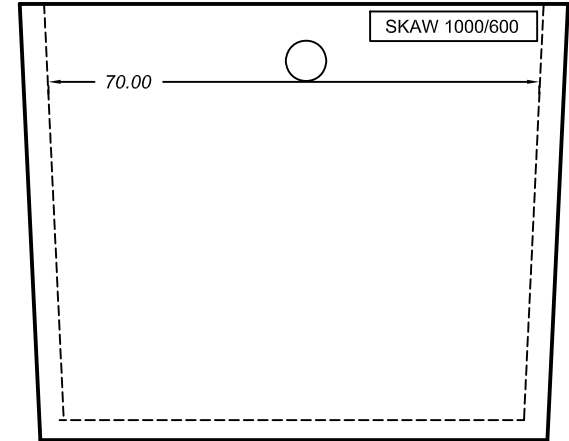

OUTLET END VIEW OF TANK

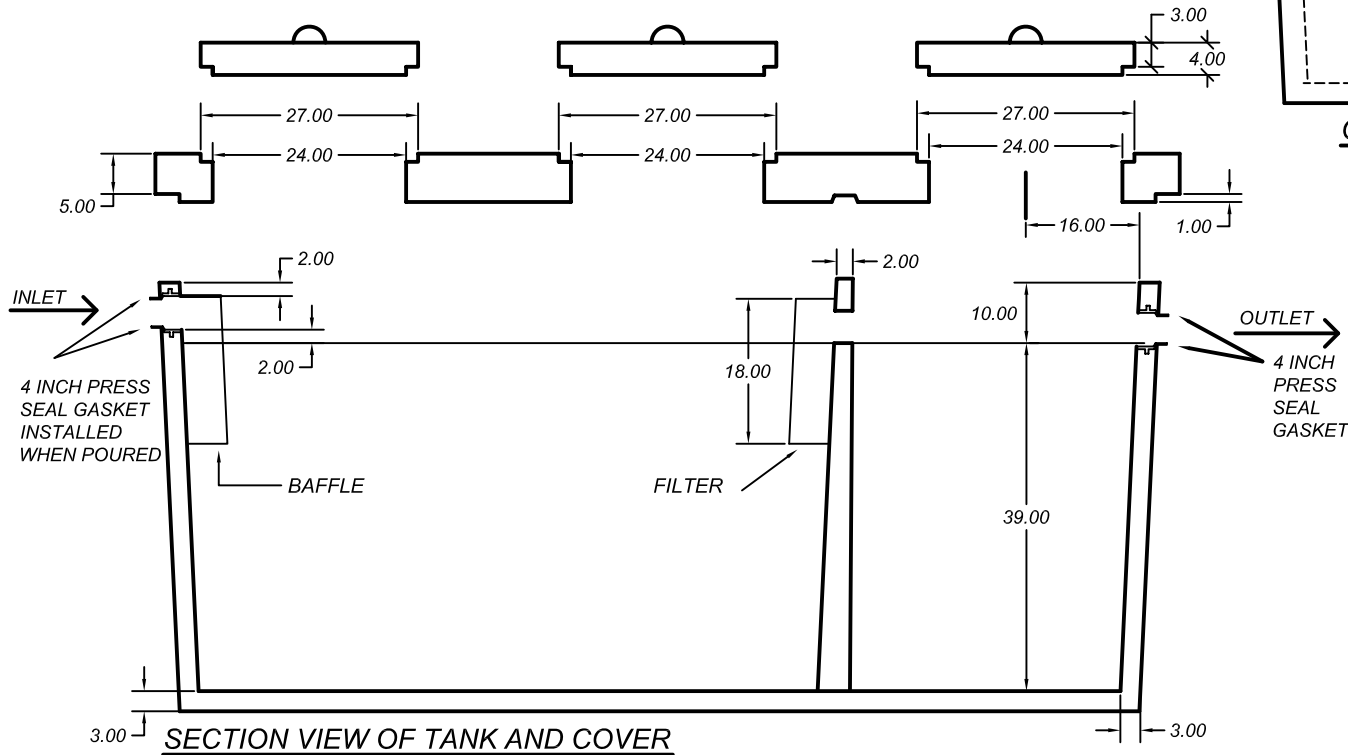

SECTION VIEW OF TANK AND COVER

Model Number: **1000 / 600**

Approved for: SEPTIC/SEPTIC, SEPTIC/PUMP, SEPTIC/SIPHON OR HOLDING

Weight	Inlet Dim.	Outlet Dim.	Liq. Depth	Gal. / In.	Nom. Cap.
13,050 lbs.	44"	42"	39"	16.47	642.33 gal.

SKAW PRE-CAST

26255 105th Street, New Auburn
Wisconsin 54757
www.skawprecast.com

Phone: (715) 967-2277
Toll Free: 1-800-924-8625
Fax: (715) 967-2707

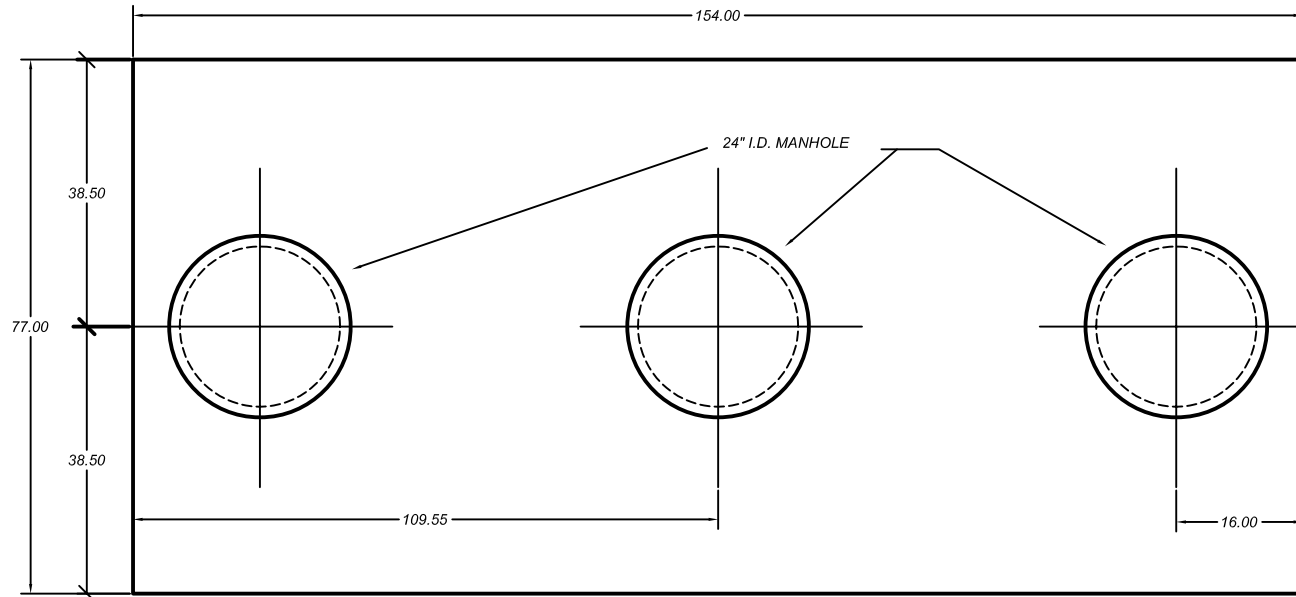

TOP VIEW OF COVER

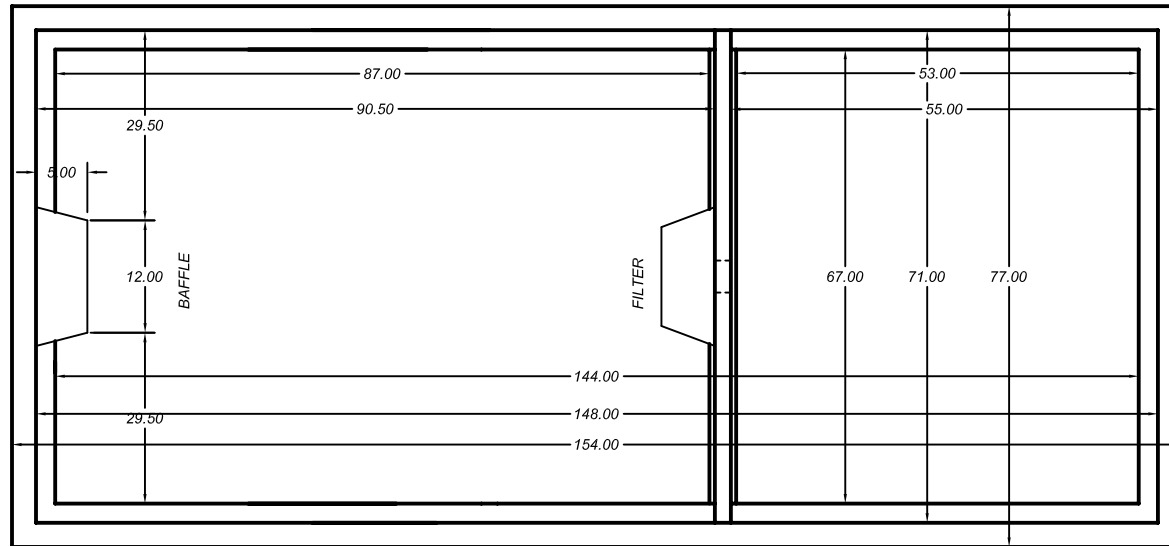

TOP VIEW OF TANK (TAPERED)

Model Number: **1000 / 600**

Approved for: SEPTIC/SEPTIC, SEPTIC/PUMP, SEPTIC/SIPHON OR HOLDING

Weight	Inlet Dim.	Outlet Dim.	Liq. Depth	Gal. / In.	Nom. Cap.
13,050 lbs.	45"	43"	39"	16.47	642.33 gal.

SKAW PRE-CAST

26255 105th Street, New Auburn
 Wisconsin 54757
www.skawprecast.com

Phone: (715) 967-2277
 Toll Free: 1-800-924-8625
 Fax: (715) 967-2707